

Stand-sit-workstations
Cutting edge performance.

We know how to create offices.

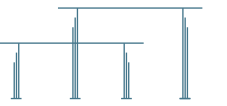



STAND-SIT-WORKSTATIONS



“My „Reform“ desk allows you to work in both sitting and standing postures, depending on your physical comfort.

Company founder - Robert Reiss
1910,

Bad Liebenwerda

Original yesterday - benchmark today.

More than 100 years ago, we developed and produced Germany's first stand-sit-desk „Reform“. Generations later, we have perfected our stand-sit-desks in every respect. Their sophisticated design and the highest standards of ergonomic functionality, quality and reliability make them the benchmark for today's height-adjustable workstations.

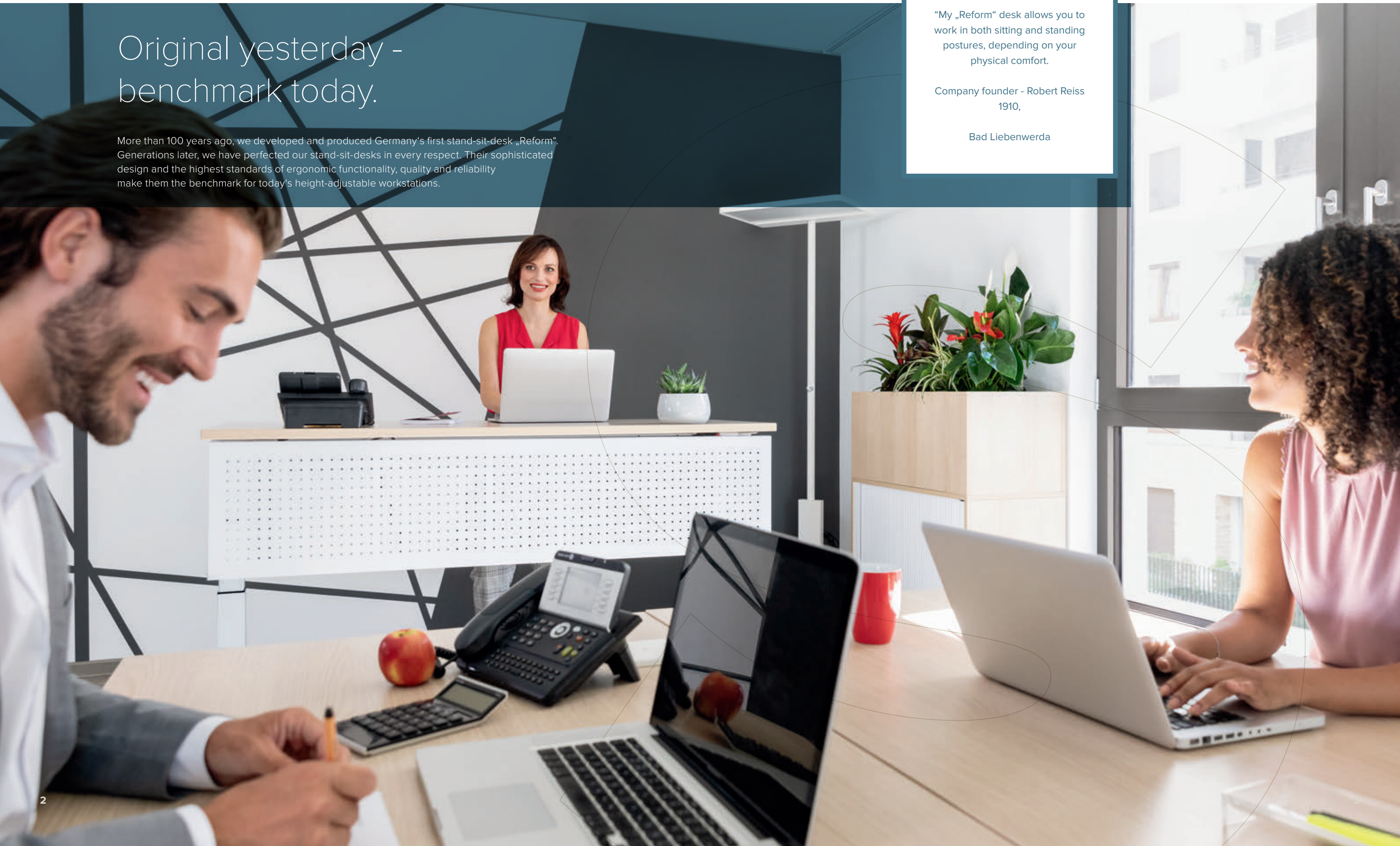

HIGHLIGHTS AND OPTIONS

- | Square column profile (70 x 70 mm)
- | Max. load capacity 100 kg
- | Different manual switches for motorised quick adjustment and customized configurations
- | Interior columns in chrome optics
- | Safety via piezo sensor with sensitive collision protection
- | Table top with sliding plate function
- | Optionally integrated desk screen for privacy
- | Extension tables possible via adapter

Square, practical, better.

Sometimes, things just have to be more sophisticated. And this is when everything points to the REISS Avaro Q, because the optional adapter, with its square column profile, permits variable configuration of the stand-sit-desks for an ergonomic communication workstation. With the REISS Avaro Q, you can make more out of your office in no time.



Motorised quick adjustment
650 – 1,250 mm
630 – 1,280 mm optional



Benchmark in comfort and performance.

The demand of today's working world is not only high, but also very complex. The REISS Avaro Q Bench offers the possibility to fully exploit the potential of each individual and to work efficiently in a team. Individual work space combined with ergonomic flexibility and communicative exchange – REISS sets new standards for stand-sit-workstations.

HIGHLIGHTS AND OPTIONS

- | Square column profile (70 x 70 mm)
- | Max. load capacity 100 kg
- | Different manual switches for motorised quick adjustment
- | Safety via Piezo sensor with sensitive collision protection
- | Table top with sliding plate function
- | Integrated horizontal cable duct
- | Intelligent cable management
- | Optional integrated desk screen for privacy
- | Metal side screen, on request with individualized logo and light

Motorised quick adjustment
650 – 1,250 mm
630 – 1,280 mm
(optional)



All around well shaped

REISS Avaro R, with a round column profile, is the right choice for those who prefer curves over straight lines. It can do much more. Compared to the REISS Avaro Basic, it can carry 30 kg more load. With its piezo sensors, it creates more safety with regard to sensitive collision protection.

The adjustment range of 630 to 1,280 mm and the two visible interior columns in chrome optic are optionally available. Excellent arguments for a well-rounded thing.

HIGHLIGHTS AND OPTIONS

- | Round column profile (Ø 70 mm)
- | Max. load capacity 100 kg
- | Different manual switches for motorised quick adjustment and customized configurations
- | Interior columns in chrome optics
- | Safety via piezo sensor with sensitive collision protection
- | Table top with sliding plate function
- | Smart cable management
- | Optionally integrated desk screen for privacy



Motorised quick adjustment
 650 – 1,250 mm
 630 – 1,280 mm optional

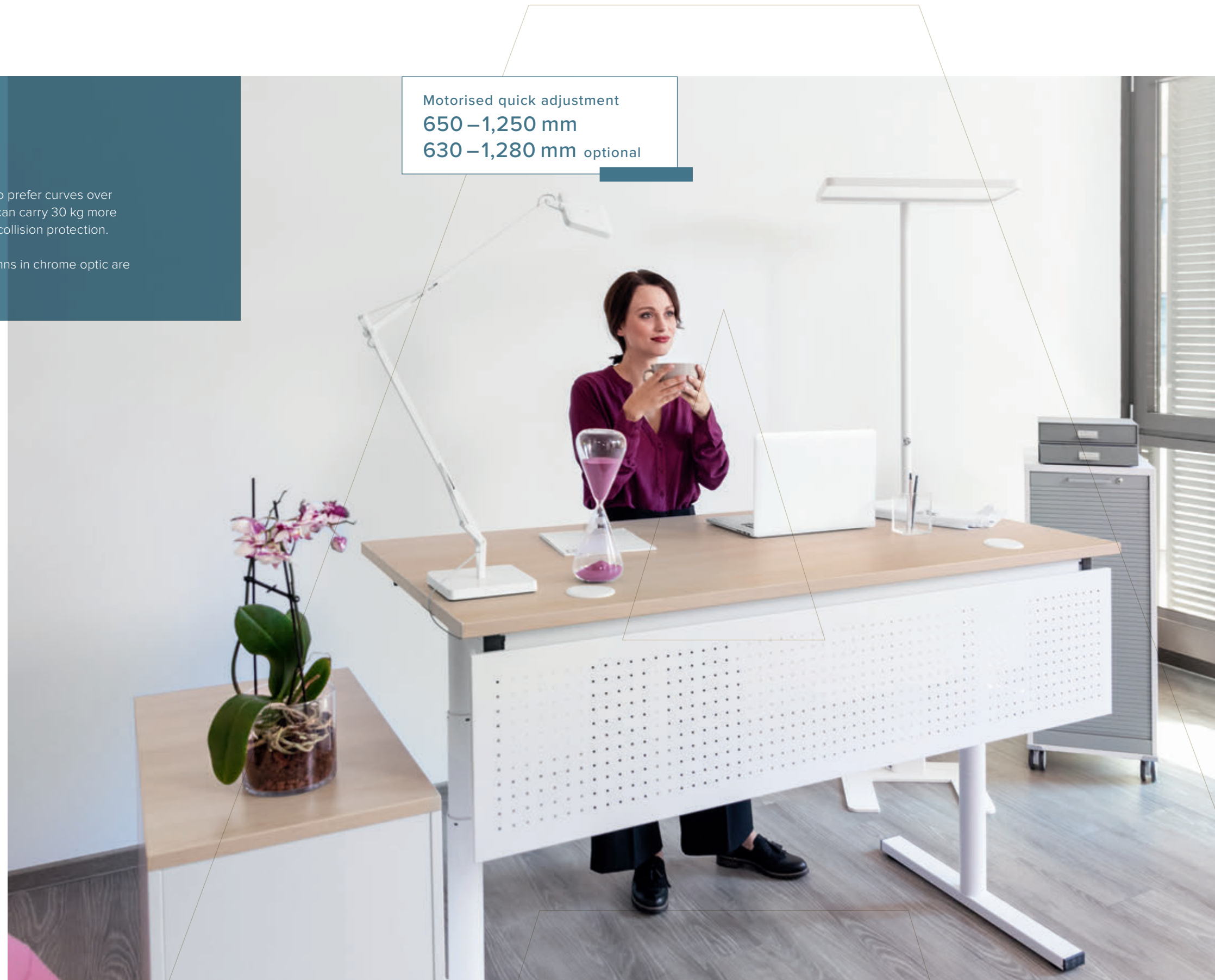

REISS Avaro Basic

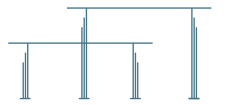

STAND-SIT-WORKSTATIONS

Dynamics for novices.

Thanks to its competitive price-performance ratio, the REISS Avaro Basic represents the perfect entry into the world of stand-and-sit ergonomics. This is because our new stand-sit-desk also comes with the tried and tested REISS expertise, combined with the quality of „Made in Germany“.

HIGHLIGHTS AND OPTIONS

- | Rectangular column profile (80 x 50 mm)
- | Max. load capacity 70 kg
- | Different manual switches for motorised quick adjustment and customized configurations
- | More safety via collision protection
- | Table top with sliding plate function
- | Smart cable management

Motorised quick adjustment
650 – 1,250 mm



All stand-sit-desks from REISS have been awarded with the GS certificate and comply with the performance features and funding conditions of the insurance companies.



Lift quick adjustment
620 – 1,280 mm

Faster and smoother runner.



HIGHLIGHTS AND OPTIONS

- | Lift table with pneumatic spring
- | Highly responsive, smooth, and practically noiseless height adjustment
- | Safety fall arrestor prevents the table top from „sagging“
- | Without motor: Maintenance and annual inspection not required
- | Interior columns in chrome optics
- | 15 kg max. load capacity
- | Table top with sliding plate function



REISS Eco V combines all the advantages of the pneumatic spring principle with those of a large table top. A gentle pressure is enough to adjust even stand-sit-tables with dimensions up to 2000x900 mm in a flash, quietly and continuously way. Thanks to its chromed interior columns and functional design, the Eco V presents a fine figure at every level.

The ideal combination of ergonomics and economy.

Motorised quick adjustment
650 – 1,250 mm

Crank lever adjustment
720 – 1,160 mm

HIGHLIGHTS AND OPTIONS

- | Control element with display and memory function slidable under table top
- | Table top with sliding plate function
- | Electrification via simple cable passage, up to modules with network, Ethernet, USB and HDMI connection
- | Smart cable management
- | Beamless frame for comfortable legroom
- | Metal legroom screen
- | Optionally integrated desk screen for privacy
- | Slim profile – elegant design

REISS Eco N2 meets all requirements for a performance-enhancing, healthy office workstation. The working height can be gradually adjusted from 720 to 1,160 mm via the quick adjustment using the removable crank lever feature. Motorised quick adjustment between 650 and 1,250 mm can be performed via a control element with display and memory function. And as the beamless frame of the serie offers comfortable legroom, is the built-in cable duct easily accessible via a sliding plate with dust-repellent brush insert. It is difficult to imagine a greater combination of ergonomics and economy.



Teamwork concept.

The desks of the REISS Eco N2 series can be connected or even retrofitted comfortably and in compliance with standards thanks to the REISS coupling. The optionally integrated privacy protection wall remains at the same height. This also ensures visual calm.

HIGHLIGHTS AND OPTIONS

- | Control element with display and memory function slidable under table top
- | Table top with sliding plate function
- | Electrification via simple cable passage, up to modules with network, Ethernet, USB and HDMI connection
- | Smart cable management
- | Beamless frame for comfortable legroom
- | Metal legroom screen
- | Optionally integrated desk screen for privacy
- | Slim profile – elegant design



REISS is very close to you. Our sales network includes more than 300 specialist retailers in Germany and Europe. You can also visit our showrooms in Bad Liebenwerda, Berlin, and Frankfurt am Main. We look forward to seeing you!



The flexible all-rounder.

The sleek and functional REISS Novo, with its single column, is unique in the stand-sit table sector. This is just one fact that makes it so incredibly flexible. Whether as a second table, for meetings in the office, or for mobile use – almost any variant and application is conceivable – thanks to the wide variety of frame and panel designs.

Lift quick adjustment
680 – 1,120 mm
720 – 1,160 mm
(with castors)



Confident maverick.

REISS Novo can also be used as a stand-sit-desk. The single-column design, with its gentle quick lift adjustment and stable base panels, are perfectly suited to meet these requirements.



HIGHLIGHTS AND OPTIONS

- | Also as mobile option with 4-way cross base and 4 double castors
- | Round or square table top with round or square column
- | Chromed column
- | Various design options
- | Standalone module or as an extension table for the desk

REISS Avaro Q

Motorised quick adjustment
650–1,250 mm
630–1,280 mm (optional)



REISS Avaro Q Bench

Motorised quick adjustment
650–1,250 mm
630–1,280 mm (optional)



REISS Eco N2 2.2

Motorised quick adjustment
650–1,250 mm



Standard:
Manuel switch with
up/ down buttons



Option:
Manuel switch with up/
down buttons
4 memory positions, display
with height indication

REISS Avaro R

Motorised quick adjustment
650–1,250 mm
630–1,280 mm (optional)



REISS Avaro Basic

Motorised quick adjustment
650–1,250 mm



REISS Eco N2

Crank lever adjustment
720–1,160 mm



REISS Eco V

Lift quick adjustment
620–1,280 mm



Manuel switches for height adjustment



Standard:
Intuitively operated
manuel switch for up/
down function



Option 1:
Manuel switch with up/
down buttons



Option 2:
Intuitively operated
manuel switch with
memory function through
light bar, 4 memory
positions, display and
Bluetooth® für Desk
Control App



Option 3:
Manuel switch with up/
down buttons,
3 memory positions,
display with height
positions



Option 4:
Switchless height
adjustment with an
intuitive wearless and
key-free sensor

REISS Novo

Lift quick adjustment
680–1,120 mm
720–1,160 mm (with castors)



REISS Eco N2 2.2

Stand-sit-workstations with motor

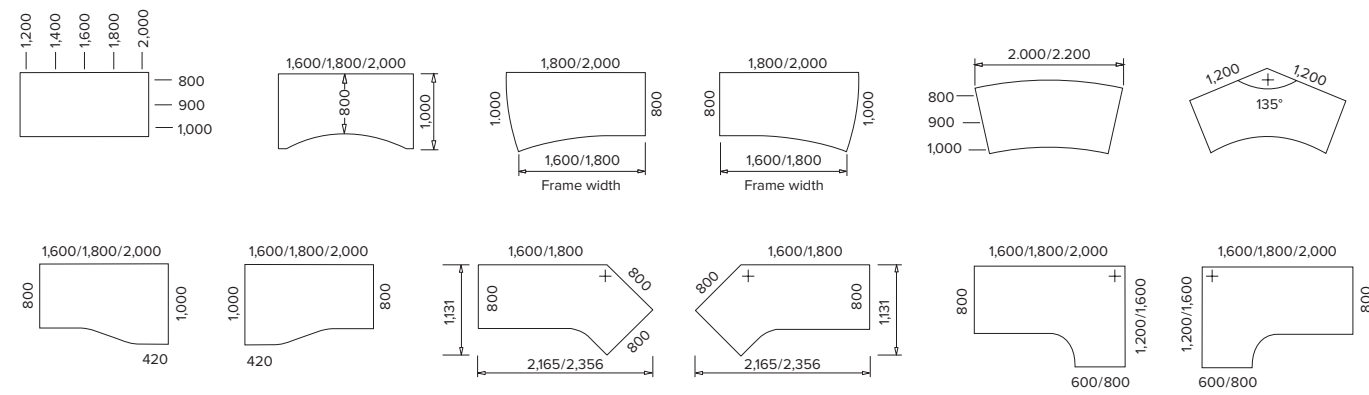

REISS Avaro Q Bench

Stand-sit-workstations with motor

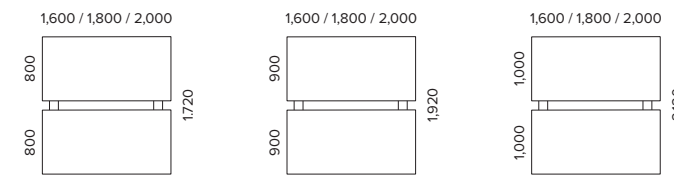

REISS Eco N2 2.2

Stand-sit-workstations with lift, crank lever

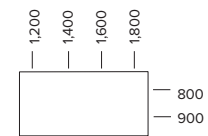

REISS Eco N2 2.2

Conference tables with motor

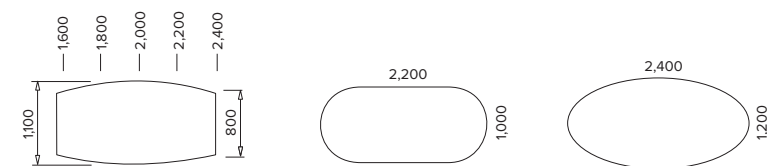

REISS Avaro

Stand-sit-workstations with motor

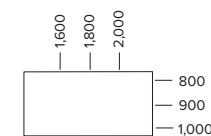

REISS Eco V

Stand-sit-workstations with lift

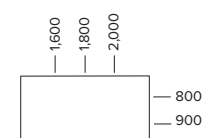

REISS Eco V

Conference tables with lift

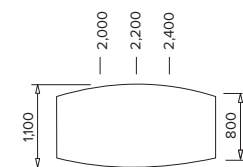

REISS Novo



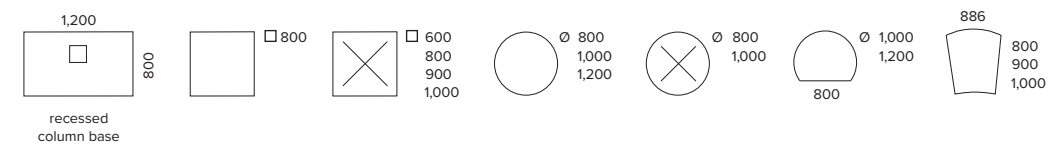





Single-column tables with lift

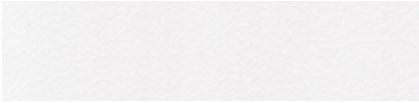
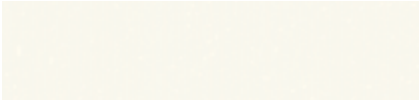
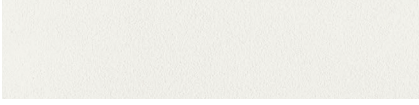
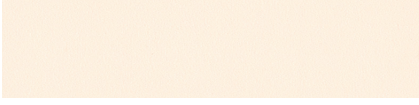







All specifications in mm.







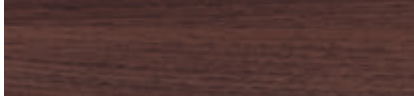

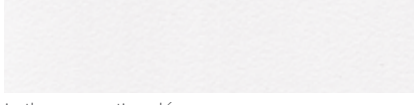
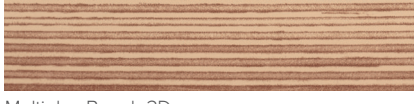
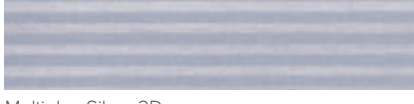
DÉCORS

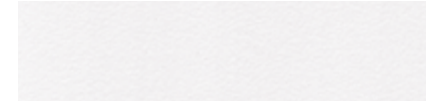
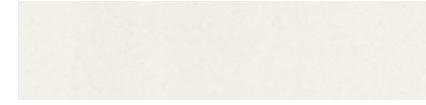
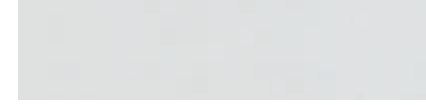
-  White
-  Office White
-  White grey
-  Jasmine
-  Sandy greige
-  Light grey
-  White aluminium
-  Royal maple
-  Maple, pale
-  Beech
-  White beech

COLOURS

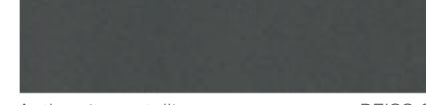
-  Calvados apple
-  Royal oak
-  Lindberg oak, pale
-  Lindberg oak grey (surface smooth)
-  Walnut
-  Anthracite
-  **EDGE BAND**
-  in the respective décor
-  Multiplex Beech 3D
-  Multiplex Silver 3D

-  White RAL 9003
-  Grey white RAL 9002
-  Light grey RAL 7035
-  Silver RAL 9006
-  Grey aluminium RAL 9007
-  Dusty grey RAL 7037
-  Anthracite RAL 7016
-  Anthracite metallic REISS 63
-  Black RAL 9011
-  Chrome

REISS Products are GS-certified. They bare the RAL-UZ 38 environmental quality seal, and meet the „Quality Office“ criteria. REISS is certified in accordance with the quality management system (DIN EN ISO 9001), the environmental management system (DIN EN ISO 14001), the product chain certificate PEFC-CoC and EMAS III.

REISS Büromöbel GmbH

04924 Bad Liebenwerda
Germany

Phone: +49 35341 48-360

Fax: +49 35341 48-368

E-Mail: info@reiss-bueromoebel.de

www.reiss-bueromoebel.de

Member of the Industrial Association
of Office and Work Environment (IBA)

